

**VALVE REGULATED GEL Battery**

**CG12-200**

CSPOWER CG series pure GEL battery is with 12-15 years floating design life, it is ideal for standby or frequent cyclic discharge applications under extreme environments. By adopting thicker grids, high purity 99.997% lead and patented Silicon Gel electrolyte, CG series offers excellent recovery performance after deep discharge under frequent cyclic discharge use, and can deliver 1200 cycles at 50% DOD even work in hot or cold area. Suitable for Solar, CATV, marine, RV and deep discharge UPS, communication, and telecommunication, etc.

<b>12V</b> Voltage	<b>200Ah</b> Capacity	<b>GEL</b> Technology	<b>Durable</b> Battery
-----------------------	--------------------------	--------------------------	---------------------------



**COMPLIED STANDARDS**



**GENERAL FEATURES**

- 30% more cyclic life through innovation at the PAM additives than AGM battery
- Long life expectancy of 15 years in floating condition
- Adopts quality silicon nano gel electrolyte
- Excellent deep discharge recovery capability
- Deep cycle performance: up to 1200 cycles @50% DOD

**APPLICATIONS**

- Telecommunications
- UPS systems, Inverter
- Power Equipments
- Solar & Wind
- Emergency & Security

**DIMENSIONS & WEIGHT**

Length(mm/inch)	522/20.55
Width(mm/inch)	240/9.44
Height(mm/inch)	219/8.62
Total Height(mm/inch)	224/8.81
Weight(kg/lbs) (±3%)	56.5/125

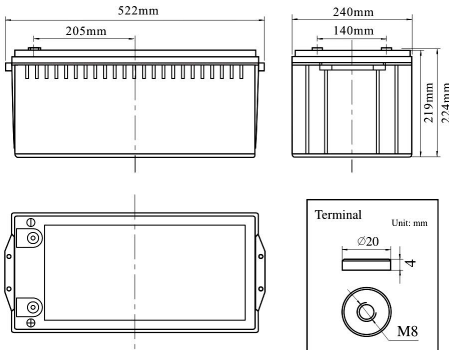

**TECHNICAL SPECIFICATIONS**

Nominal Voltage		12V(6 cells per unit)
Design Floating Life @25°C		15 Years
Nominal Capacity @25°C(10 hour rate@20.0A,10.8V)		200Ah
Capacity @25°C	20hour rate (11.0A,10.8V)	220Ah
	5 hour rate (35.4A,10.5V)	177Ah
	1 hour rate (132A,9.6V)	132Ah
Internal Resistance	Full Charged Battery@25°C	≤2.5mΩ
Ambient Temperature	Discharge	-20°C~60°C
	Charge	-10°C~60°C
	Storage	-20°C~60°C
Max.Discharge Current@25°C		1200A (5s)
Capacity affected by Temperature (10 hour)	40°C	105%
	25°C	100%
	0°C	85%
	-15°C	65%
Self-Discharge@25°C per Month		3%
Charge (Constant Voltage) @25°C	Standby Use	Initial Charging Current Less than 50A Voltage 13.6-13.8V
	Cycle Use	Initial Charging Current Less than 50A Voltage 14.4-14.9V

**BATTERY DISCHARGE TABEL**

**Discharge Constant Current per Cell (Amperes at 25°C)**

F.V/Time	15min	30min	45min	1h	2h	3h	4h	5h	8h	10h	20h
1.60V	309.5	206.4	148.1	132.0	81.8	55.0	46.2	37.4	24.6	22.0	12.1
1.65V	303.9	202.6	145.4	129.6	80.4	54.0	45.4	36.7	24.2	21.6	11.9
1.70V	298.3	198.9	142.7	127.2	78.9	53.0	44.5	36.0	23.7	21.2	11.7
1.75V	292.7	195.1	140.0	124.8	77.4	52.0	43.7	35.4	23.3	20.8	11.4
1.80V	281.4	187.6	134.6	120.0	74.4	50.0	42.1	34.0	22.4	20.0	11.0

**Discharge Constant Power per Cell (Watts at 25°C)**

F.V/Time	15min	30min	45min	1h	2h	3h	4h	5h	8h	10h	20h
1.60V	595.9	397.2	285.0	254.1	157.5	105.9	89.0	72.0	47.4	42.4	23.3
1.65V	585.0	390.0	279.8	249.5	154.7	104.0	87.4	70.7	46.6	41.6	22.9
1.70V	574.2	382.8	274.7	244.9	151.8	102.0	85.7	69.4	45.7	40.8	22.4
1.75V	563.4	375.6	269.5	240.2	148.9	100.1	84.1	68.1	44.8	40.0	22.0
1.80V	541.7	361.1	259.1	231.0	143.2	96.3	80.9	65.5	43.1	38.5	21.2

**Note:** The above data are average values, and can be obtained within 3 charge/discharge cycles. These are not minimum values. Cell and battery designs/specifications are subject to modification without notice. Contact CSPOWER for the latest information.

**VALVE REGULATED GEL Battery**

**CG12-200**

**PERFORMANCE CHARACTERISTICS**

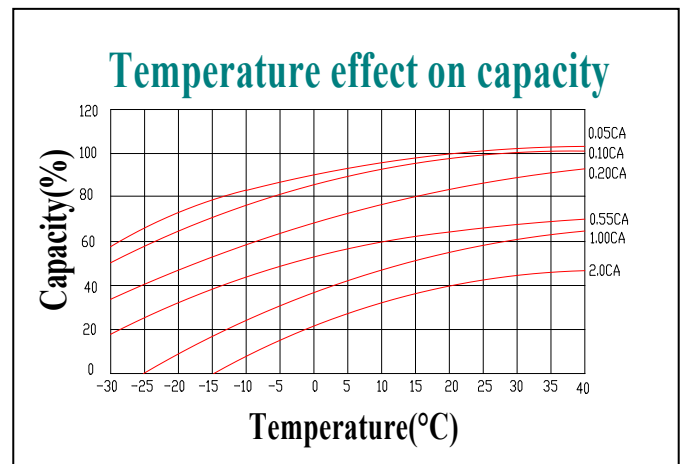
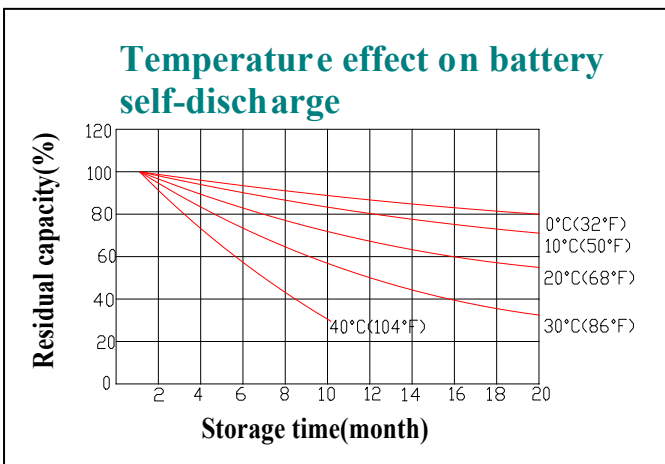
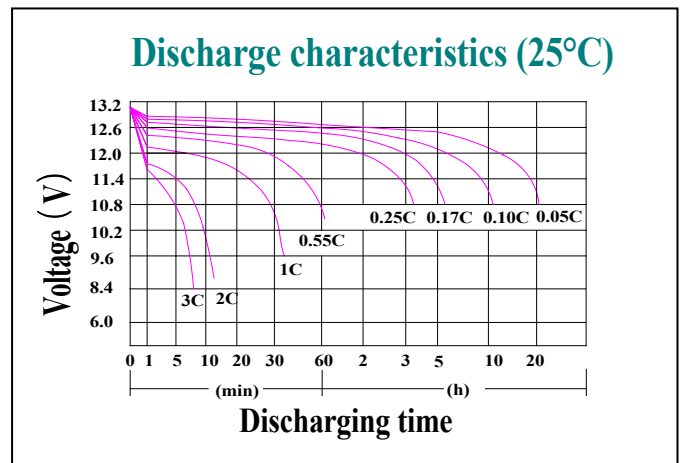
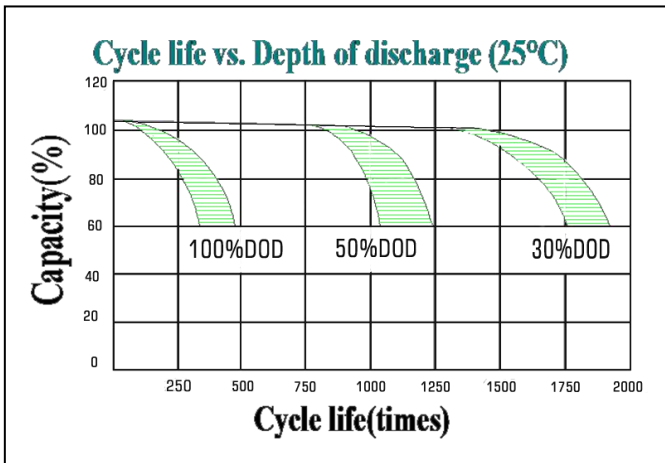
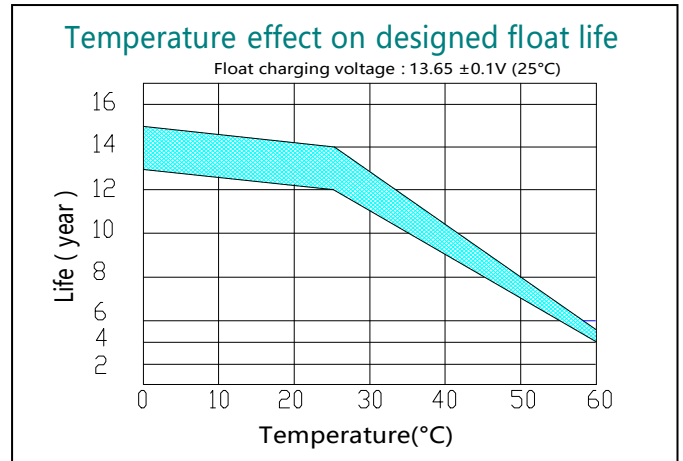
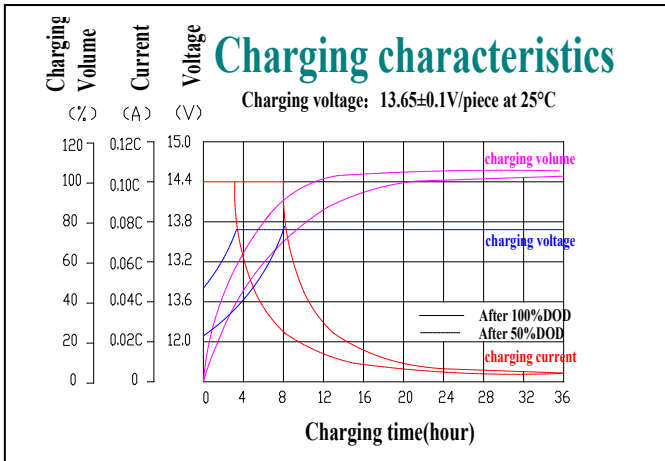

**BATTERY CONSTRUCTION**

Component	Positive plate	Negative plate	Container & Cover	Safety valve	Terminal	Separator	Electrolyte	Pillar seal
Features	Thick high Sn low Ca grid with special paste	Balanced Pb-Ca grid for improved recombination efficiency	Fire resistance ABS (UL94-V0)	Flame Si-Rubber and aging resistance	Female Copper Insert M8	Advanced PVC /AGM separator for high pressure cell design	Silicon Gel	Two layers epoxy resin seal

**Shenzhen CSPOWER Battery Technology Co.,Ltd.**

Add: Building B, Huafeng Technology Park, Baoan, Shenzhen, China.

Tel: +86-755-29123661 Email: sales@csagmbattery.com



[HTTP://WWW.CSAGMBATTERY.COM](http://www.csagmbattery.com)